

shower channel CeraLine Plan F Duo 1900 mm, DN 50

Part number: 524560
 GTIN: 4001636524560
 Rebate group: 8

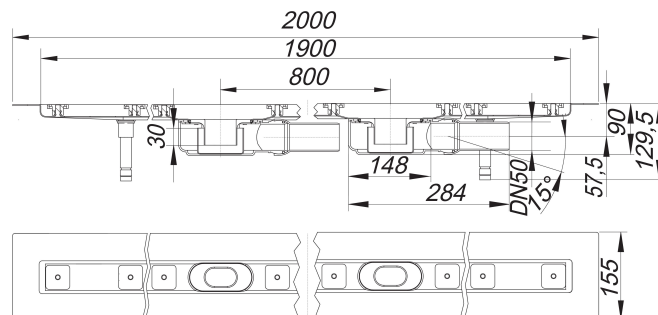

Description:

shower channel CeraLine Plan F Duo 1900 mm, DN 50
 Linear drainage
 with two drain bodies, outlet DN 50 horizontal, ball-joint adjustable 0 – 15 degrees

specification

- sound-insulated height adjustable levelling legs
- integral sand coated flange for secure bonding of under-tile waterproofing
- removable trap insert, 30 mm water seal (deviating to DIN EN 1253)
- height adjustable pedestals for levelling the cover-plate
- temporary blanking plate
- tiling gauges
- tile-trim jig

material

channel 304 stainless steel, trap polypropylene

Options for CeraLine Plan F Duo:

Any made-to-measure length up to 2000 mm can be supplied. Please enquire!

The outlet connector can be supplied in ABS to suit British Standard sizes and PE-HD conforming to DIN EN 1519. Please enquire.

Flow rates tested to DIN EN 1253:

Nominal diameter	Product standard	Min. flow rate according to norm	Water level according to norm
DN 50	DIN EN 1253	0.80 l/s	20.00 mm

Spare parts:

523983 adjustable pedestals