

## shower channel CeraLine W, 800 mm, BS 2"

Part number: 521347  
 GTIN: 4001636521347  
 Rebate group: 8

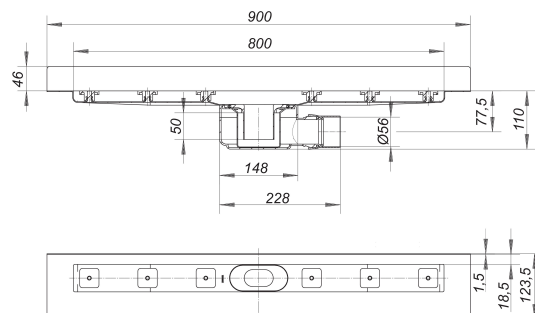
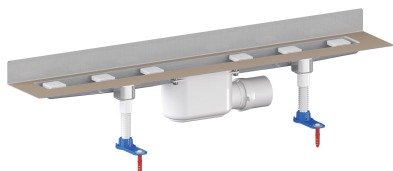

### Description:

shower channel CeraLine W, 800 mm, BS 2"

conforming to DIN EN 1253

Linear drainage for installation at wall, with one drain body, outlet horizontal, ball-joint adjustable 0 – 15 degrees, DN 50, BS 2" sw socket or HDPE 56 mm

#### specification

- sound absorbing height adjustable levelling legs
- integral sand coated flange for secure bonding of under-tile waterproofing
- removable trap insert, 50 mm water seal (conforming to DIN EN 1253)
- height adjustable screws
- temporary blanking plate
- tiling gauges
- edge trim jigs

#### material

channel 304 stainless steel, trap polypropylene

#### Options for CeraLine W:

- Any made-to-measure length up to 1200 mm can be supplied
- Upstands can be on back, back and one end or back and both ends
- Upstand can be set back for stone, marble wall finish

Please enquire!

CeraLine 600 mm – 1100 mm can be used with the Poresta® BFR 75 unit!

The outlet connector can be supplied in ABS to suit British Standard sizes and PE-HD conforming to DIN EN 1519. Please enquire.